



PETRIN A SPIRALE - ELECTROMECHANIQUE SPIRAL KNEADER - ELECTROMECHANICAL

PEB200MS



Photos non contractuelles / Photos not contractual

- 2 vitesses
- Cuve et outil inox
- Grille de protection relevable
- Capacités : Cuve = 290 L
Farine = 133 kg
Pâte = 200 kg
- 2 moteurs indépendants (cuve et outils)
- 2 minuteries
- Passage automatique de la vitesse
- Tableau de commande électromécanique
- Transmission par courroies
- Pieds avant réglables
- Marche arrière
- Possibilité de rotation de la cuve par impulsion
- 400/50Hz/3
- Puissance : 1ère vitesse = 6.5 kW
2ème vitesse = 11 kW
- Puissance moteur cuve : 1.1 kW
- Poids net : 830 kg

Options :

- 60 Hz - Tableau électronique

- 2 speeds
- Stainless steel bowl and tools
- Stainless steel raising safety grid
- Capacity : Bowl = 290 L
Flour = 133 kg
Dough = 200 kg
- 2 independent motors (bowl and tools)
- 2 timers
- Automatic change of operating speeds
- Electromechanic control panel
- Belt transmission
- Adjustable front feet
- Bowl reverser switch
- Possibility to rotate bowl by pulse
- 400/50Hz/3
- Power : 1st speed = 6.5 kW
2nd speed = 11 kW
- Bowl motor power : 1.1 kW
- Net weight : 830 kg

Options :

- 60 Hz - Electronical control panel

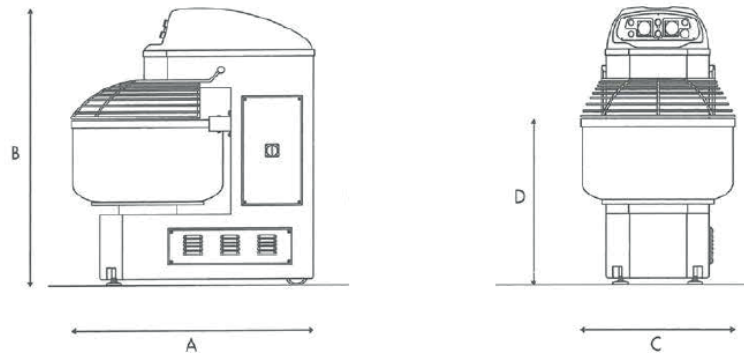

A = 1490 mm
B = 1560 mm
C = 930 mm
D = 910 mm

